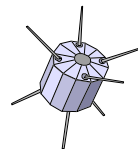

**TEMIC / MATRA MHS
RADIATION TOLERANT SPARC PROCESSOR**

by Dominique de SAINT ROMAN

**ESA / ESTEC SPARC DAY
October 1, 96**

AGENDA

- TEMIC
- MATRA space strategy and product offering
- Radiation tolerant SPARC program
- SPARC status
- SPARC performances
- SPARC offering
- SPARC development support
- Forecast/conclusion



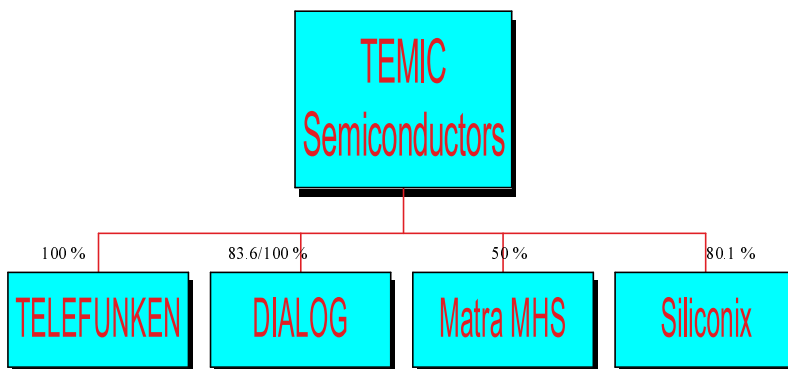
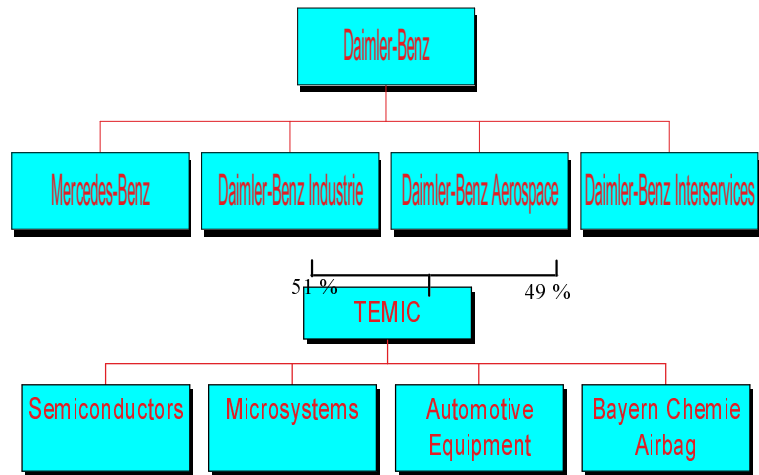

Revenue Structure by Market Segments

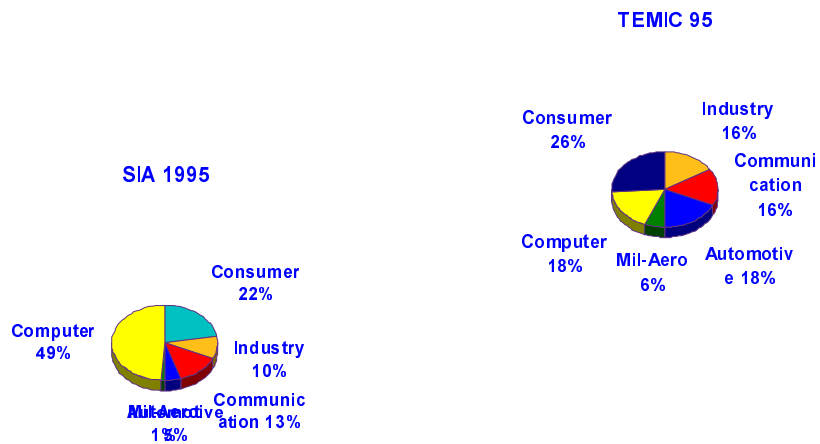

TEMIC DUAL USE

- RT processes are only slight deviations from standards
- Non RT & RT products are mask compatible
- Non RT & RT products take advantage of volume based production:
 - ▼available in any packages to any quality grades
 - ▼better manufacturing & quality control
 - ▼broader innovation capability
 - ▼lower manufacturing cost
 - ▼better reproducibility
 - ▼better longevity

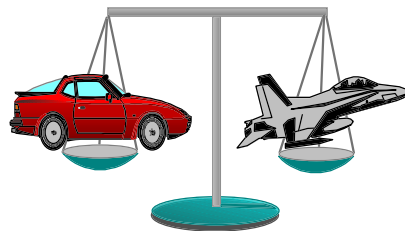

TEMIC DUAL USE

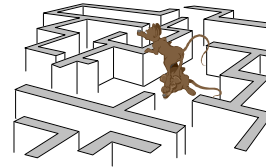

- TEMIC has been a pioneer, from company day one
- The only long term reliable route to keep servicing space
- The only route for space advanced technology availability
- The TEMIC brochure supports and emphasizes that strategy
- William PERRY supports it
- And everybody wants now to go that way !

TEMIC
Semiconductors

Space products offering

ASICs :

Gate array in CMOS 0.8µm : MCRT ----> 50K, 100 MHz
Sea of gates in CMOS 0.6µm : MG1RT ----> 480Kcells 250 MHz @ 5 V
Sea of gates in CMOS 0.5µm : MG2RT ----> 500Kcells 250 MHz @ 3V (Q497)
Sea of gates in CMOS 0.5µm : MG2RT ----> 500Kcells 350 MHz @ 5V (Q497)
Full Custom in CMOS RT 0.8 to 0.5 µm
 in CMOS RT+ 0.6 µm (Q197)
 in BICMOSRT 0.8 µm
 in DMILL 0.8 µm (Q297)

MEMORIES

VLP SRAMs :
 16K, 64K, 256K, 1Mbits (Q4 96)
 VLP FIFOs :
 512 to 16K x9, 15ns, 200µA
 VLP DPRs :
 1Kx8 MS to 8Kx16 MS, 20ns, 200µ

ASSPs :

16 and 32 bit EDACs, Discrete Cosine Transform
 High Speed Data Link Tx/Rx (Q496)
 Viterbi, Reed Solomon (Q197)

MICROS

Fast 8 bit µC :
 80C32 30MHz
 32 bit RISC :
 SPARC µP chipset: IU, FPU, MEC
 SPARClet µC (Q497)
 32 bit floating point DSP :
 TSC21020E, 20 MIPs (Q297)

ULC :

FPGA conversions

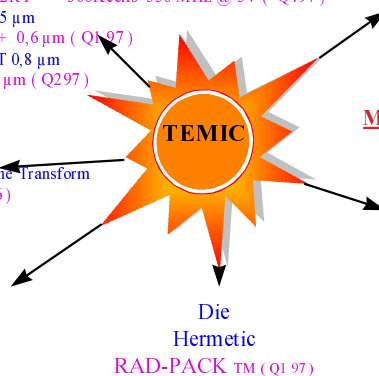

RAD-PACK is a SEI trademark

A Company of Daimler-Benz

Services offering

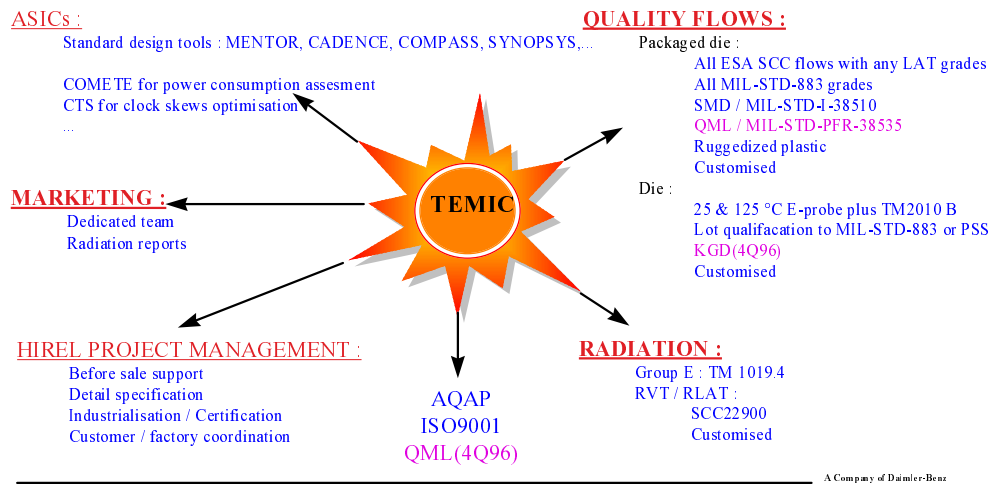

Historical Context

- ESA intended to launch a new Microprocessor development programme
- Need of a space 32 bits Microprocessor from a European supplier
- Only MIL31750 was available on SOS technology, and wasn't powerful enough
- MHS was a good candidate with the SPARC architecture, and also thanks to its advanced radiation tolerant technology .
- Then, the SES, Matra Marconi Space and MHS consortium was selected to design a 32 b Computer named ERC 32 .

32 BIT SPARC PRODUCT LINES

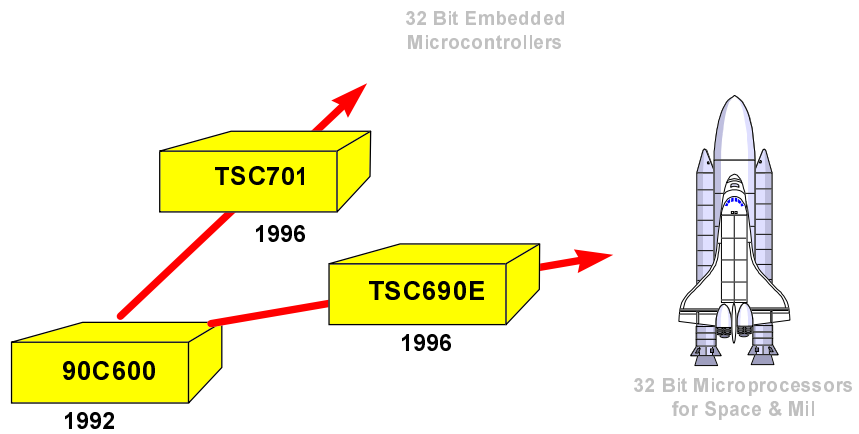

MHS SPARC program

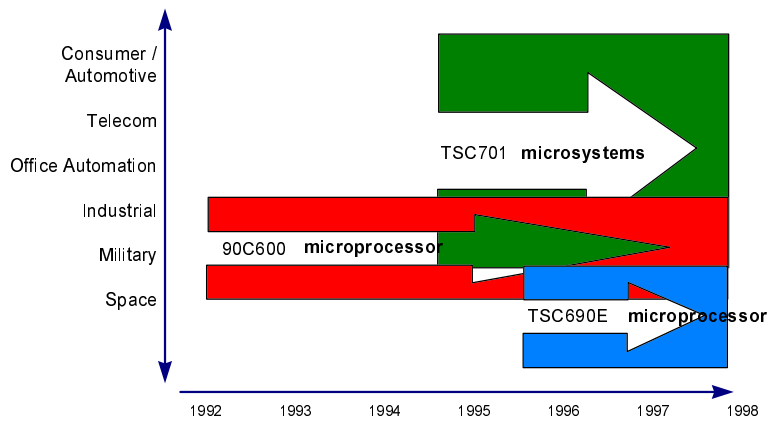

TSC690E status

- Respective chips revision C, B and A are validated on DMS-R (beta site)
- Available :
 - ▼691E(IU), 692E(FP) and 693E(MEC) VHDL models
 - ▼respective chips revision are C, B and A
- Specifications :
 - ▼rev G, dated 10/09/96 for 691E and 692E
 - ▼rev B, dated 23/04/96 for 693E.
- Order entry open for C, B and A chips
- Irradiation completed :
 - ▼total dose at DCAN (France)
 - SEU and latchup at Brookhaven Labs (USA)

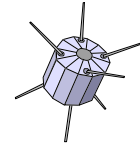

TSC690E features

- Full functional compatibility with former 90C601 (IU) & 90C602 (FP)
- 100% compatible with SPARC V7
- Concurrent Error Detection
- Testability :
 - ▼Off-line testing with, at least, 95% fault coverage
- System self test after Power-On Reset covering 90% of the core
- Performance :
 - ▼10 Mips / 2 Mflops (SP) @ 14 MHz
- Power consumption :
 - ▼lower than 5 W (ERC32) @ 10 Mips
- Operating conditions :
 - ▼temperature range : -55°C to +125°C
 - ▼voltage range : 4.5V to 5.5V

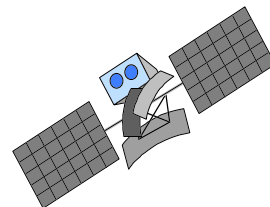

TSC690E radiation features

- Total dose radiation (Gamma) :
 - ▼base line better than 50 Krads (Si)
 - ▼dual use process approach allowing non RT & RT versions
- SEU LET Threshold better than 15 MeV / cm²
- Latch up free (better than 100MeV)
- and over 97% of all SEU induced faults are detected and trapped

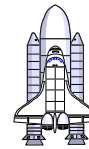

Fault tolerant & test mechanisms

- Parity checking for all latches with generation of hardware error traps
- Parity checking for address, data & control busses
- Possibility to disable bus parity checking (internal still working)
- Master / checker operation for 691E and 692E
- Interleaving of register file bits for better SEU detection
- IEEE standard test access port
- Internal scan path
- Halt mode
- Program flow control (691E only)
- Operating & stand by power consumption reduction
- Process & design improvements for SEU & total dose
- Manufactured on space hardened 0.8 μm CMOS process

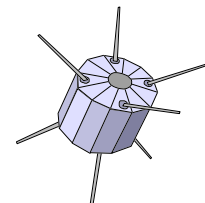

TSC691E features

- Full software compatibility with 90C601
- 8 windows register files
- FPU interface allows concurrent execution of FP instructions
- User / supervisor modes for multitasking
- Fault tolerant & test mechanisms improvements
- Packaged into an MQFPF256(as TSC693E)

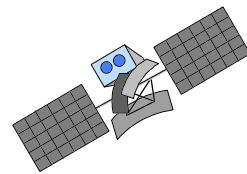

TSC691E diagram

TSC692E features

- Compatibility with 90C602 instructions set
- Full compliance with ANSI/ IEEE 754 for binary FP arithmetic
- 90C602E never generates unfinished FP operation exception
- Supports single and double precision FP operations
- Tightly coupled IU interface
- 64 bit ALU and multiplier/divide/square root
- 16 64-bit or 32 32-bit registers in 3 port FP register file
- Fault tolerant & test mechanism improvements
- Packaged into an MQFPL160

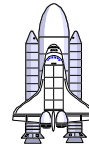

TSC692E diagram

TSC693E features

- Address decoding & memory interface
- Wait state generation
- Interrupt controller
- 32-bit SEC/DED
- Two 32-bit timers
- Two UARTs
- Boot PROM interface
- DMA interface
- Error manager
- Watchdog
- Packaged into MQFPF256 (as TSC691E)

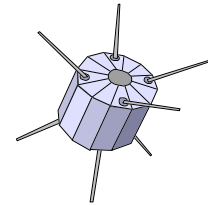

TSC693E diagram

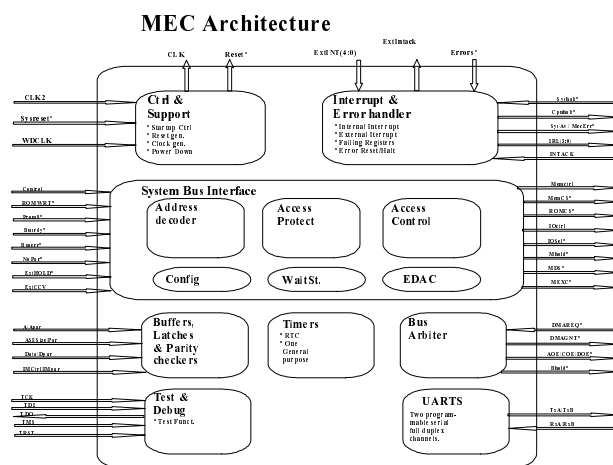

Exemple of chips association

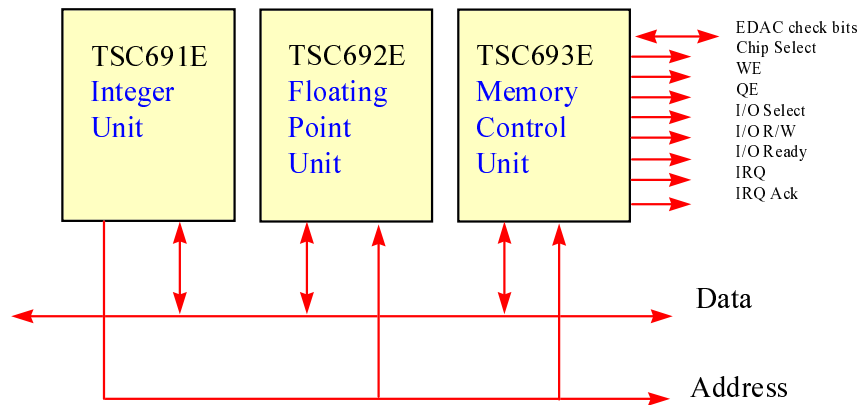

Master/Checker Operation

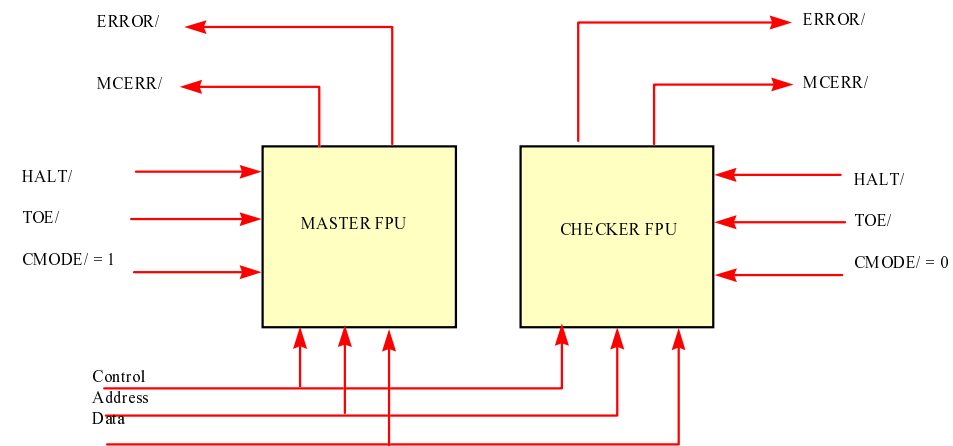

Targetted applications

- TSC691E/TSC692E/TSC693E applications :
 - ▼ HARD REAL TIME
 - Attitude Orbit Control Satellite (AOCS),Control Navigation Guidance for Launcher,Spacecraft, Satellite platforms
 - ▼ DATA PROCESSING
 - Mission computer, Data management/storage for larger satellite and shorter ground communications
 - Dedicated payload processing
 - Workstations for Space stations
 - ▼ DATA HANDLING
 - Communication management
 - Data compression (image : earth observation, datacommunication).
 - ▼ SMALL SATELLITE MULTIPLE COMPUTER USAGE
 - ▼ EMBEDDED APPLICATION

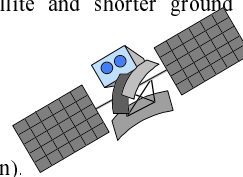

Strengths

- Strong ESA recommendation for future developments
- Baseline for a majority of the new European Computer developments
- SPARC software available and standard ADA language can be used
- Many hardwares available for prototype development
- Capability to evolve towards Sparclet core for the new generation
- Well known RISC instructions set
- Well adapted for multi application development
- TEMIC silicon for good traceability

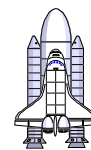

ERC32 quality flows

- So far, only delivered as packaged die, as follows :
 - ▼ a -E flow, which stands for engineering, which TEMIC will have available from the shelves, most of the time,
 - ▼ a -2 flow, which are parts packaged according MHS mil flow, with a mil temp range operating guarantee, build on orders,
 - ▼ a P883 flow, which stands for MIL-STD-883 level B plus PIND test (TM2020 condition A), build on orders,
 - ▼ a SB flow, which stands for SCC9000 level B, build on orders.

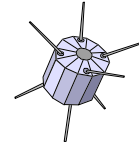

ERC32 software development tools : compilers & kernels

PRODUCTS	COMPANY	AVAILABILITY	PRICE
ALSYS ADA	TSP / Alsys UK	Beta now	
VxWORKS C/C++	Wind River France	Available	
GNU C/C++	Public domain	Available	Free
RTEMS C/C++ RT kernel	OAR US	Available	Free
Rational ADA	Rational France	Available	

**ERC32 software development tools :
simulators, debugger, analysis**

PRODUCTS	COMPANY	AVAILABILITY	PRICE
ERC32SIM (ERC32 simulator)	SPACEBEL Belgium	Available	?
SIS (ERC32 simulator)	ESTEC	Available	Free
GDB & DDD (debugger and graphic user interface)	Public domain	Available	Free
Execution analysis tools	SPACEBEL Belgium	?	?

**ERC32 software development tools :
hardwares**

PRODUCTS	COMPANY	AVAILABILITY
VME Common Processor Board	MMS France	Available + specification
DEM32 ERC32 evaluation board	SES	Available + specification
AVECS VME board	DASA	?
SPARC RT VME single board computer	THARSYS France	?
